

Installation Manual of Tank Trim

Please show the manual to final customer.

General Drawing

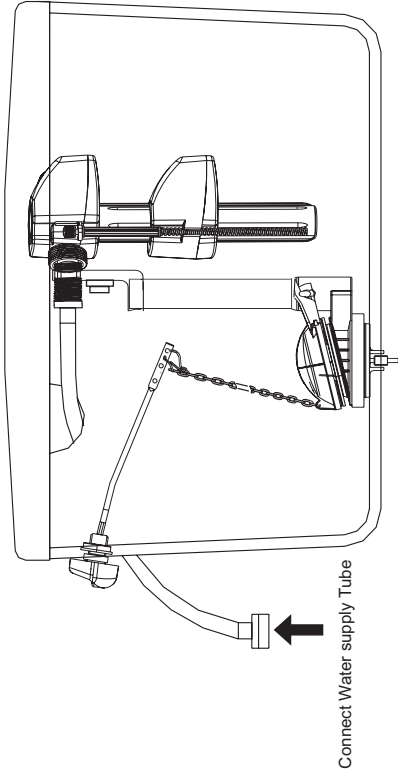

WARNING:

Do not use an in-tank type bowl cleaner in your toilet. In-tank cleaners containing chlorine(calcium hypochlorite) can seriously damage fittings in the tank. We shall not be responsible for any tank fitting damage caused by the use of cleaners containing chlorine(calcium hypochlorite). We will not be liable for damages due to improper handling or installation, abuse, or alteration of the product. We disclaims any responsibility for incidental or consequential damages.

Installation

1. Installation of fill valve

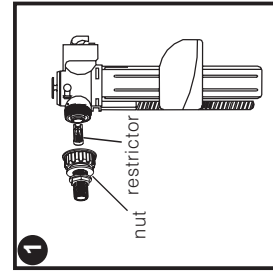

Note: when the water pressure is lower than 0.4Mpa, turning on the nut and bringing out the restrictor.

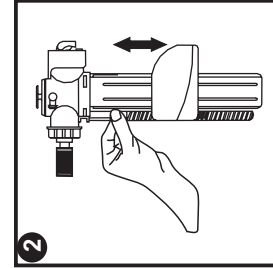

Rotating the adjustment rod can make the float move up and down to preadjust the water level height.

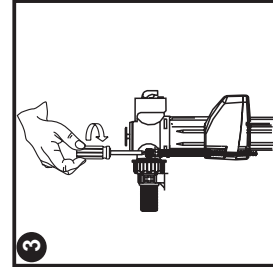

Rotating the adjustment rod can make the float move up and down to preadjust the water level height.

2.The installation of flush valve

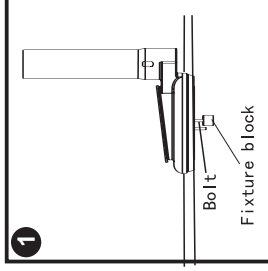

Screw the flush valve tight, and make sure the fixture block and seal washer attach on the tank wall. Put the flapper on the flush valve .

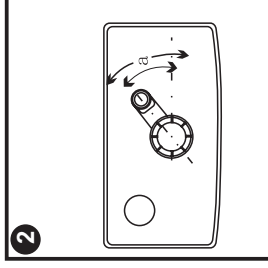

Adjust the angle of the flush valve, make sure the flapper is easy to open, and the chain is not blocked.

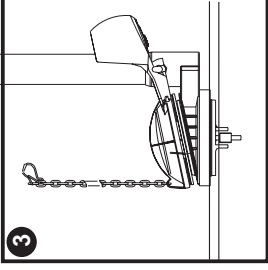

Screw the flush valve tight, and make sure the fixture block and seal washer attach on the tank wall. Put the flapper on the flush valve .

3.Installation of push button

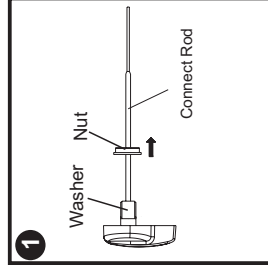

Loose the nut clockwise take away the nut and the washer from the rod.

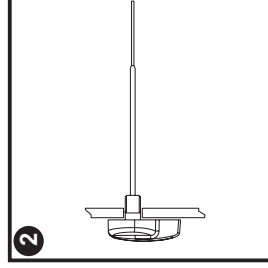

Install the rod into the tank handle hole.

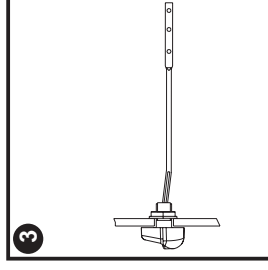

Enter the nut on the handle and tighten.

Attention: If the product is different from the drawing , Please take the object as right.